

Operating instructions for the system user

TOSHIBA

DHW heat pump
HWS-G1801CNHVM-E
Cylinder capacity 178 l

HWS-G1801CNHVM-E



For your safety

-  Please follow these safety instructions closely to prevent accidents and material losses.

Safety instructions explained

-  **Danger**
This symbol warns against the risk of injury.

Note
Details identified by the word "Note" contain additional information.

-  **Please note**
This symbol warns against the risk of material losses and environmental pollution.

Target group

These operating instructions are intended for system users.
This appliance can also be operated by children aged 8 and older, as well as by individuals with reduced physical, sensory or mental faculties or those lacking in experience and knowledge, provided such individuals are supervised or have been instructed in the safe use of this appliance as well as in any risks arising from it.

-  **Please note**
Supervise children in the proximity of the appliance.
- Never permit children to play with the appliance.
 - Cleaning and user maintenance must never be carried out by unsupervised children.

Safety instructions for working on the system

Connecting the appliance

- The appliance may be connected and commissioned only by authorised contractors.
- Observe the specified electrical connection requirements.
- Modifications to the existing installation may only be carried out by authorised specialists.

-  **Danger**
Incorrectly executed work on the system can lead to life threatening accidents.
Work on electrical equipment may only be carried out by a qualified electrician.

For your safety (cont.)**Working on the appliance**

- All settings and work on the appliance must be performed as specified in these operating instructions. Further work on the appliance may be carried out only by authorised contractors.
- Do not open the appliance.
- Do not remove casings.
- Do not modify or remove attachments or fitted accessories.
- Do not open or tighten pipe connections.

**Danger**

Hot surfaces can cause burns.

- Do not open the appliance.
- Do not touch the hot surfaces of uninsulated pipes and fittings.

Auxiliary components, spare and wearing parts**Please note**

Components that were not tested with the system may cause system damage, or may affect its functions. Have all installation or replacement work carried out exclusively by heating contractors.

Safety instructions for operating the system**If there is a fire****Danger**

Fires create a risk of burns.

- Switch the system off.
- Use a tested fire extinguisher, class ABC.

Conditions for siting**Danger**

Easily flammable liquids and materials (e.g. naphtha/petrol, solvents, cleaning agents, paints or paper) can cause deflagration and fire.

Never store or use such materials in the boiler room or in direct proximity to the heating system.





**Please note**

Incorrect ambient conditions can result in system damage and can put safe operation at risk.

- Maintain the permissible ambient temperatures as detailed in the operating instructions.

- **Appliance for indoor installation:**

- Avoid air contamination through halogenated hydrocarbons (e.g. as in paints, solvents and cleaning agents).
- Avoid continuously high humidity levels (e.g. through continuous drying of washing).









1. Introductory information	Symbols	6
	Intended use	6
	Product information	7
	■ HWS-G1801CNHVM-E	7
	Commissioning	7
	■ Permissible air intake temperatures	7
	Your system is preset at the factory	7
	Energy saving tips	8
	Tips for greater comfort	8
2. Control unit operation	Programming unit	9
	■ Default display	9
3. DHW heating	Setting the standard DHW temperature	10
	Operating programs	10
	■ Menu overview	10
	■ Setting operating programs	11
	■ Application limits	11
	■ "ECO" operating program	11
	■ "SMART" operating program	12
	■ "AUTO" operating program	12
	■ "BOOST" operating program	12
	■ "OUT"  operating program (holiday program)	13
	■ "PROGRAM" operating program 	14
	■ "NIGHT" operating program 	14
	Setting a time program	15
	DHW demand	16
	Increased DHW hygiene	16
4. Power from a photovoltaic system	Utilisation of power generated on site	16
5. Further settings	Setting the time and day	17
	Premium/economy tariff	17
	■ Enable premium/economy tariff	17
	Minimum stop time function	17
	Childproofing	17
	Restoring factory settings (reset)	18
6. Checks	Checking information	19
	Checking messages	19
7. Switching on and off	Switching off the DHW heat pump	20
	■ With frost protection monitoring	20
	■ No frost protection monitoring	20
	Switching on the DHW heat pump	20
	■ After being taken out of use or a power failure lasting longer than 24 hours	20
	■ "OUT"  operating program (standby mode, holiday program)	20
8. What to do if...	DHW heat pump does not start	21
	No input is possible at the programming unit	21
9. Maintenance	Cleaning	22
	Inspection and maintenance	22
	■ DHW cylinder	22
	■ Safety valve (DHW cylinder)	22
	■ Potable water filter (if installed)	22
	■ Damaged cables/lines	22

Index (cont.)

10. Keyword index 24

Introductory information

Symbols

Symbol	Meaning
	Reference to other document containing further information
	Step in a diagram: The numbers correspond to the order in which the steps are carried out.
	Warning of material losses and environmental pollution
	Live electrical area
	Pay particular attention.
	<ul style="list-style-type: none">▪ Component must audibly click into place. or▪ Acoustic signal
	<ul style="list-style-type: none">▪ Fit new component. or▪ In conjunction with a tool: Clean the surface.
	Dispose of component correctly.
	Dispose of component at a suitable collection point. Do not dispose of component in domestic waste.

Intended use

The appliance is intended solely for installation and operation in sealed unvented heating systems that comply with EN 12828, with due attention paid to the associated installation, service and operating instructions.

The appliance may only be used for heating DHW.

The range of functions can be extended with additional components and accessories.

Intended use presupposes that a fixed installation in conjunction with permissible, system-specific components has been carried out.

Commercial or industrial use for purposes other than domestic hot water heating shall be deemed inappropriate.

Any usage beyond this must be approved by the manufacturer in each individual case.

Incorrect use or operation of the appliance (e.g. the appliance being opened by the system user) is prohibited and will result in an exclusion of liability. Incorrect use also occurs if the components in the heating system are modified from their intended function.

Note

The appliance is intended exclusively for domestic use, i.e. even users who have not had any instruction are able to operate the appliance safely.

Product information

HWS-G1801CNHVM-E is a DHW heat pump with integral DHW cylinder.

The heat pump uses the thermal energy in the indoor or outdoor air for DHW heating.

An immersion heater can provide booster heating when the DHW demand is at its highest.

The heat pump is available for **recirculation air mode**, **outdoor air mode** and **recirculation air mode with air discharge to the outside**.

Recirculation air mode

In recirculation air mode, the thermal energy from the ambient air (indoor air in the installation room) is used for DHW heating. The air cooled down by this process is discharged back into the installation room by the DHW heat pump.

When DHW is being heated, the installation room is cooled and dehumidified.

Recirculation air mode with air discharge to the outside

As in recirculation air mode, the DHW is heated with the thermal energy from the indoor air. The cooled air is discharged to the outside through a ductwork system. At the same time, fresh air enters the installation room through an outdoor air aperture.

Outdoor air mode

In outdoor air mode, outdoor air is supplied to the DHW heat pump via a duct.

The air cooled down during DHW heating is discharged directly to the outside via a further duct.

Commissioning

The commissioning and matching up of the heat pump control unit to local conditions and to the structural characteristics of the building, plus the instruction of the user in operating the system, must be carried out by your heating contractor.

Permissible air intake temperatures

The DHW heat pump switches off outside the permissible air intake temperatures. In some operating programs, DHW can also be heated outside the permissible air intake temperatures, through the use of an immersion heater (accessories).

Permissible air intake temperatures:

- For DHW heating in recirculation air mode and recirculation air mode with air discharge to the outside (temperature in the installation room):
+3 °C to +35 °C
- For DHW heating in outdoor air mode (outside temperature):
-5 °C to +35 °C

Your system is preset at the factory

Your DHW heat pump is preset at the factory and is therefore ready for operation.

DHW heating

- DHW is heated to 54 °C (set DHW temperature) every day from **00:00 to 24:00**.

Day and time

- The day and time have been set by your contractor.

You can change the settings at any time to suit your individual requirements.

Power failure

All settings are retained for 24 hours if there is a power failure.

Energy saving tips

- **DHW consumption:**
Consider showering instead of running a bath. A shower generally uses less energy than a full bath.
- **Low DHW demand** (see page 16):
Heat up the DHW cylinder less often.
For this, consult your contractor.
- **Time program** (see page 15):
Switch off DHW heating, for example at night or if you are going away for a long time. Set this via the time program.
- **Immersion heater:**
Switch off automatic DHW cylinder reheating by the immersion heater. Set the **"ECO"** operating program.

Utilisation of power generated on site (in conjunction with a photovoltaic system)

- Use the power generated by your photovoltaic system for DHW heating (see page 16).

For additional energy saving functions of the heat pump control unit, please contact your contractor.

Tips for greater comfort

- **Higher DHW demand:**
Heat up the DHW cylinder more often. For this, consult your contractor (see page 15).
- Use the immersion heater for automatic DHW cylinder reheating, e.g. at low ambient or outside temperatures, or if the DHW heat pump develops a fault.
Set the **"AUTO"** operating program.
- **"BOOST" operating program** (see page 12):
You can heat up the DHW cylinder immediately, regardless of the time program. For quick heat-up, set the **"BOOST"** operating program.
- **Preheating:**
Use the **"ECO"** operating program to preheat the DHW cylinder to the maximum set DHW temperature of the heat pump.
 - ! **Please note**
Operating the system with incorrect settings will result in appliance damage.
Do not set the set DHW temperature of the heat pump higher than 45 °C for preheating.

Programming unit

Default display

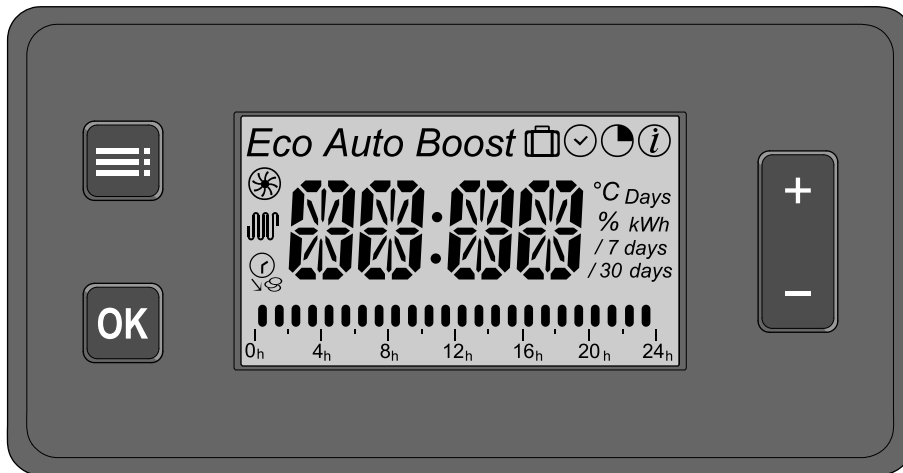

Fig. 1

+/- Scrolls through the menu or adjusts values.
OK Confirms your selection or saves the setting made.

- ☰ Selects the operating program.
- Calls up time programs.
- Displays information.
- Takes you one step back in the menu.
- Terminates an adjustment in progress.

Display	Meaning	See page
Eco	"ECO" operating program is selected.	10
Eco + Auto	"SMART" operating program is selected.	10
Auto	"AUTO" operating program is selected.	10
Boost	"BOOST" operating program is selected.	12
📅	"OUT" operating program is selected.	20
⏴	Display and set times.	17
🌞 + PROG	"PROGRAM" operating program is selected.	15
🌙 + Night	"NIGHT" operating program is selected.	10
ℹ️	Display information.	19
☀️	Heat pump is enabled.	
☀️ flashes.	Heat pump starts once the minimum stop time has expired.	17
🌊	Immersion heater is enabled.	—
🏠	Premium/economy tariff is enabled.	17
🏠 flashes.	Economy tariff is active.	—
Star rotates	Increased DHW hygiene function is active.	16
📊 0h 4h 8h 12h 16h 20h 24h	Display of set time phases	17

You can set the standard water temperature in the "ECO", "AUTO", "PROGRAM", "NIGHT" and "BOOST" operating programs (see page 10).

In the "SMART" operating program, you can select the comfort level (see page 10).

Setting the standard DHW temperature

Factory settings: 54 °C

2. OK to confirm

To change the standard DHW temperature, press the following buttons:

1. +/- for the selected value

Operating programs

Menu overview

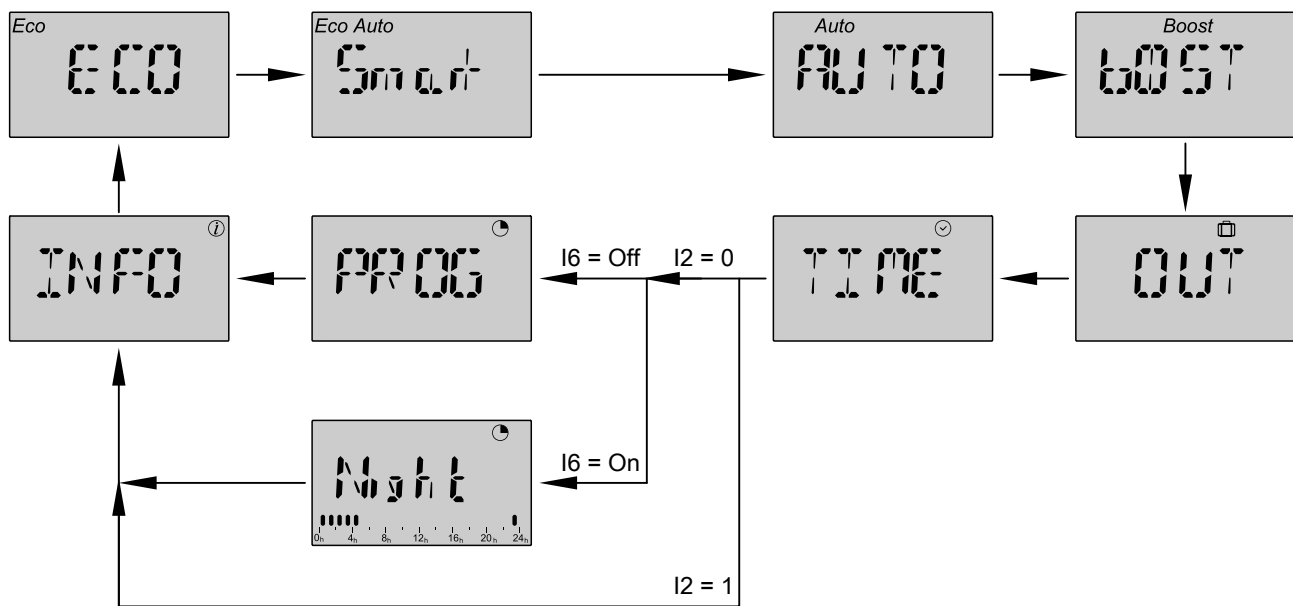

Fig. 2

I2 = 0 Installation without premium/economy tariff
For further information on the premium/economy tariff, please contact your heating contractor.

1 Installation with premium/economy tariff
For further information on the premium/economy tariff, please contact your heating contractor.

I6 = Setting for the "PROGRAM" operating program

- Off Standard
- On NIGHT mode: Optimum heating of DHW cylinder between 23:00 and 5:00.

Operating program	See page
"ECO"	11
"SMART"	12
"AUTO"	12
"BOOST"	12
"OUT" (holiday program)	13
"PROGRAM"	14
"NIGHT"	14

Operating programs (cont.)

Setting operating programs

Use  to select the required operating program.

Application limits

Note

The heat pump only switches on at outside temperatures between -5 and 35 °C. Outside this range, the immersion heater may be activated.

Note

The DHW temperature that the heat pump can achieve depends on the air intake temperature. The maximum is 62 °C.

Example: Heat pump in outdoor air mode

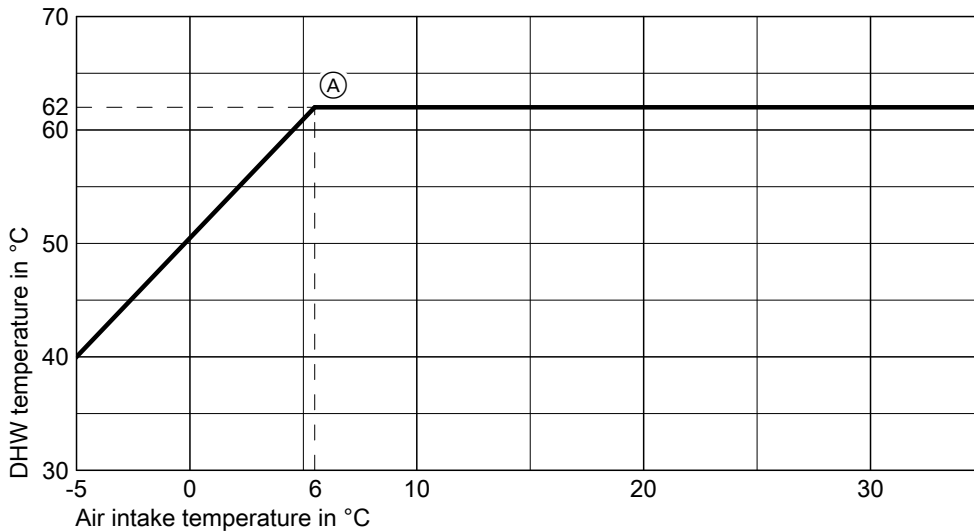

Fig. 3

(A) DHW temperature achievable with the heat pump: 62 °C

"ECO" operating program

DHW is **only** heated by the heat pump and only up to the max. DHW temperature of the heat pump.

Outside temperature from -5 °C to $+35$ °C

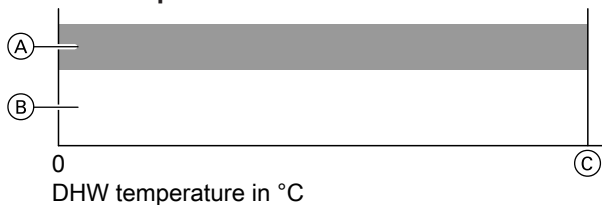

Fig. 4

- (A) Heat pump
- (B) Immersion heater
- (C) DHW temperature achievable with the heat pump

Outside temperature below -5 °C or above $+35$ °C

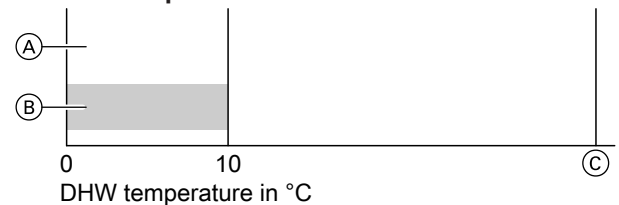

Fig. 5

- (A) Heat pump
- (B) Immersion heater
- (C) DHW temperature achievable with the heat pump

Operating programs (cont.)

"SMART" operating program

DHW is heated by the heat pump according to the learned draw-off profile. The control unit determines the times for DHW heating based on the times when you regularly draw off DHW. The immersion heater is only switched on if the heat pump cannot reach the set standard DHW temperature due to the outdoor air temperature being too low.

Setting options: Comfort level SM1 (economy) to SM5 (comfort)

Level	Comfort	Economy	Set DHW temperature in °C (min./max.)
SM1	--	++	45/57
SM2	-	+	45/60
SM3	=	=	45/62
SM4	+	-	50/62
SM5	++	--	55/62

Outside temperature above -2.5 °C

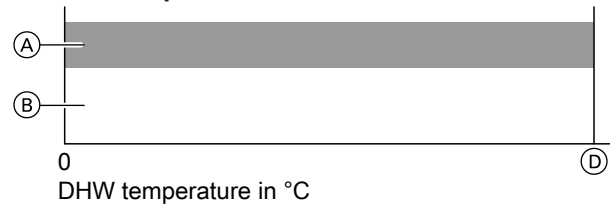

Fig. 6

Outside temperature below -2.5 °C

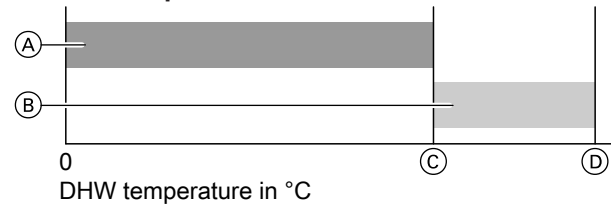

Fig. 7

- (A) Heat pump
- (B) Immersion heater
- (D) DHW temperature achievable with the heat pump

- (A) Heat pump
- (B) Immersion heater
- (C) DHW temperature achievable with the heat pump
- (D) Standard DHW temperature

"AUTO" operating program

DHW is heated by the heat pump as a priority.

The immersion heater is started automatically depending on the air intake temperature and the set DHW temperature.

Outside temperature from -5 °C to +35 °C

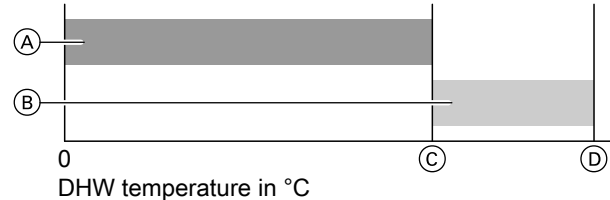

Fig. 8

Outside temperature below -5 °C or above +35 °C

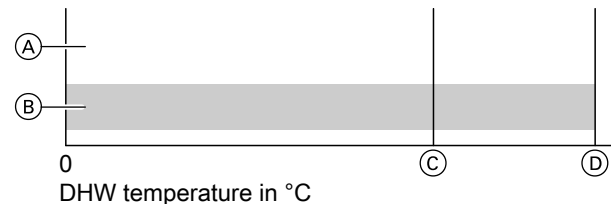

Fig. 9

- (A) Heat pump
- (B) Immersion heater
- (C) DHW temperature achievable with the heat pump
- (D) Standard DHW temperature ("AUTO")

- (A) Heat pump
- (B) Immersion heater
- (C) DHW temperature achievable with the heat pump
- (D) Standard DHW temperature ("AUTO")

"BOOST" operating program

Quick heat-up

Operating programs (cont.)

DHW is heated by the heat pump **and** immersion heater to reach the standard DHW temperature as quickly as possible.

You can adjust the standard DHW temperature at any time.

As soon as the standard DHW temperature has been reached, the heat pump control unit switches back to the operating program that was previously activated.

Outside temperature from $-5\text{ }^{\circ}\text{C}$ to $+35\text{ }^{\circ}\text{C}$

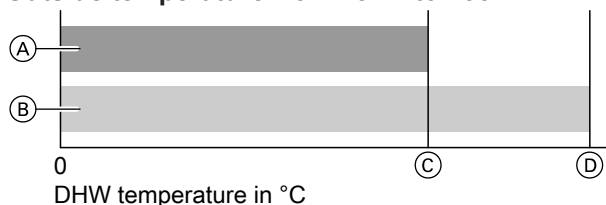

Fig. 10

- (A) Heat pump
- (B) Immersion heater
- (C) DHW temperature achievable with the heat pump
- (D) Standard DHW temperature ("BOOST")

To end the **"BOOST"** operating program early, select a different operating program.

Note

- After starting, the heat pump will always run for a specified minimum runtime.
- Operating an immersion heater results in higher power consumption.

Outside temperature below $-5\text{ }^{\circ}\text{C}$ or above $+35\text{ }^{\circ}\text{C}$

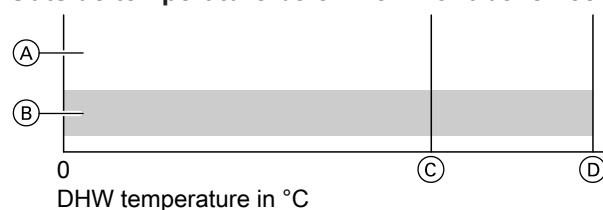

Fig. 11

- (A) Heat pump
- (B) Immersion heater
- (C) DHW temperature achievable with the heat pump
- (D) Standard DHW temperature ("BOOST")

"OUT" operating program (holiday program)

Standby mode with frost protection for the DHW heat pump: Only minimal heating of the DHW ($3\text{ }^{\circ}\text{C}$). The duration in days can be adjusted.

Outside temperature from $-5\text{ }^{\circ}\text{C}$ to $+35\text{ }^{\circ}\text{C}$

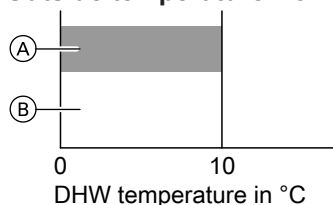

Fig. 12

- (A) Heat pump
- (B) Immersion heater

Outside temperature below $-5\text{ }^{\circ}\text{C}$ or above $+35\text{ }^{\circ}\text{C}$

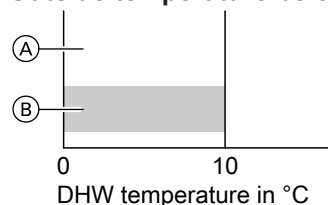



Fig. 13

- (A) Heat pump
- (B) Immersion heater

Setting the "OUT" operating program (holiday program)

1. Use  to select the  operating program. "OUT" is displayed. After 3 seconds, "-- --" flashes.
2. Use +/- to select the duration in days.

Note

If you want frost protection for an indefinite time, do not enter anything.

3. Confirm with **OK**.

Note

One day before the selected time expires, the operating program that was set before the "OUT"  program is activated.

Operating programs (cont.)

"PROGRAM" operating program 

As with the "AUTO" operating program, but DHW is heated during the time phases set in the time program; see page 15.

DHW heating enabled

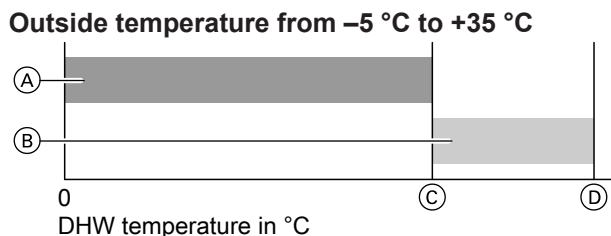

Fig. 14

- (A) Heat pump
- (B) Immersion heater
- (C) DHW temperature achievable with the heat pump
- (D) Standard DHW temperature ("AUTO")

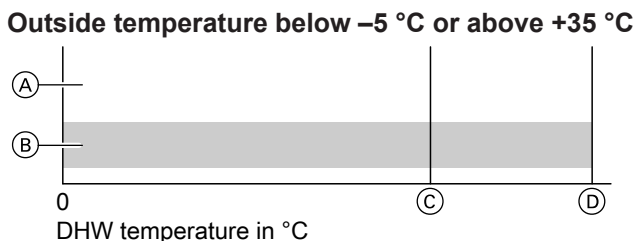

Fig. 15

- (A) Heat pump
- (B) Immersion heater
- (C) DHW temperature achievable with the heat pump
- (D) Standard DHW temperature ("AUTO")

DHW heating not enabled

Note

The immersion heater is only switched on for frost protection.

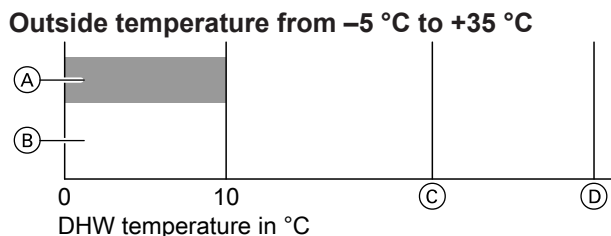

Fig. 16

- (A) Heat pump
- (B) Immersion heater
- (C) DHW temperature achievable with the heat pump
- (D) Standard DHW temperature ("PROG")

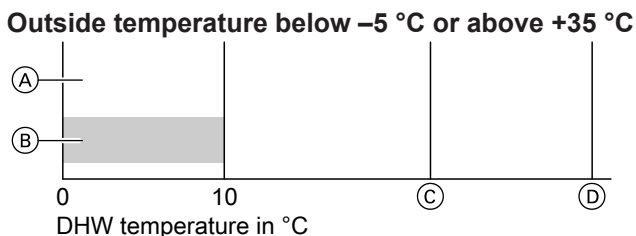

Fig. 17

- (A) Heat pump
- (B) Immersion heater
- (C) DHW temperature achievable with the heat pump
- (D) Standard DHW temperature ("PROG")

"NIGHT" operating program 

As with the "AUTO" operating program, but DHW is heated between 23:00 and 5:00. The start of DHW heating is selected so that the standard DHW temperature is reached at 5:00.

The immersion heater is switched on if the heat pump cannot reach the standard DHW temperature.

Operating programs (cont.)

DHW heating enabled

Outside temperature from $-5\text{ }^{\circ}\text{C}$ to $+35\text{ }^{\circ}\text{C}$

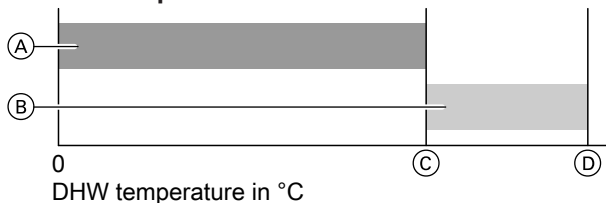

Fig. 18

- (A) Heat pump
- (B) Immersion heater
- (C) DHW temperature achievable with the heat pump
- (D) Standard DHW temperature ("AUTO")

Outside temperature below $-5\text{ }^{\circ}\text{C}$ or above $+35\text{ }^{\circ}\text{C}$

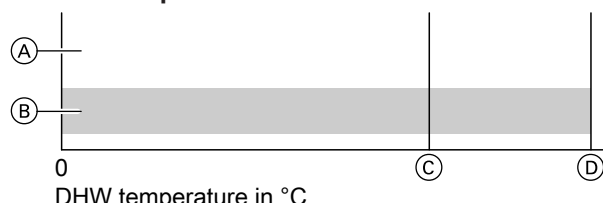

Fig. 19

- (A) Heat pump
- (B) Immersion heater
- (C) DHW temperature achievable with the heat pump
- (D) Standard DHW temperature ("AUTO")

DHW heating not enabled

Note

The immersion heater is only switched on for frost protection.

Outside temperature from $-5\text{ }^{\circ}\text{C}$ to $+35\text{ }^{\circ}\text{C}$

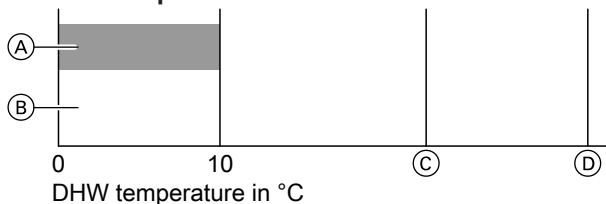

Fig. 20

- (A) Heat pump
- (B) Immersion heater
- (C) DHW temperature achievable with the heat pump
- (D) Standard DHW temperature ("PROG")

Outside temperature below $-5\text{ }^{\circ}\text{C}$ or above $+35\text{ }^{\circ}\text{C}$

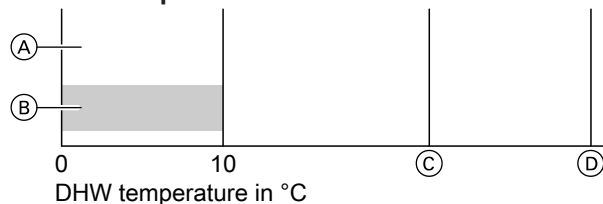

Fig. 21

- (A) Heat pump
- (B) Immersion heater
- (C) DHW temperature achievable with the heat pump
- (D) Standard DHW temperature ("PROG")

Setting a time program

In the time program, you define when DHW is heated in the "PROGRAM" operating program.

Settings	Explanation
"WEEK"	You can set a time program that is the same every day of the week.
	You can set separate time programs for each day:
"MON"	Monday
"TUE"	Tuesday
"WED"	Wednesday
"THU"	Thursday
"FRI"	Friday
"SAT"	Saturday
"SUN"	Sunday

Note

Please note that your DHW heat pump requires some time to heat the water to the required temperature. Set DHW heating to start earlier accordingly.

Changing the time program

1. Use to select the "PROGRAM" operating program.
2. Press and hold **OK** for 3 seconds. "WEEK" or "MON" is displayed.
3. Use **+/-** to select a day.
or
Press **+** for 3 seconds if you want to keep "WEEK".



DHW heating

Setting a time program (cont.)

4. Confirm with **OK**.
5. Use +/- to select an hour.
6. Confirm with **OK**.
DHW heating is switched on during the highlighted hour.
7. Select further hours.
8. To save, press and hold **OK** for 3 seconds.
"SAVE" appears.

9. Repeat these steps for the other days.

Note

- If no button is pressed for 30 seconds, the program closes without saving. "EXIT" appears.
- If the time and day have not yet been set, the heat pump control unit will ask you to do this. See page 17.

DHW demand

The draw-off profile can be changed from L (2 people) to XL (4 people) to accommodate a higher DHW demand or provide greater convenience. This change may only be made by your contractor.

Increased DHW hygiene

This function allows you to improve the microbiological quality of the water in the DHW cylinder. To ensure increased DHW hygiene, the drinking water in your DHW cylinder can be heated to 60 °C at regular intervals. Your contractor can set this function at the control unit and select an interval between 1 and 30 days.

This function switches on regardless of the selected operating program. During DHW heating for increased DHW hygiene, the symbol next to the DHW temperature rotates.

Power from a photovoltaic system

Utilisation of power generated on site

You can use the power generated by your photovoltaic system for DHW heating.



For this, consult your contractor.

Further settings

Setting the time and day

To use the **"PROGRAM"**  operating program, it is essential to set the time and day.

Changing the time and day

1. Use : to select the time setting .
The time and day are shown alternately.
2. Press **OK** to change the displayed value.
3. Change the value with **+/-**.
4. Confirm with **OK**.
The value has been changed.

Display	Meaning
"MON"	Monday
"TUE"	Tuesday
"WED"	Wednesday
"THU"	Thursday
"FRI"	Friday
"SAT"	Saturday
"SUN"	Sunday

Premium/economy tariff



Your power supply utility can offer special electricity tariffs for the operation of a heat pump. With these tariffs, the electricity price changes automatically depending on the time of day.

The electricity price is higher in the premium tariff than in the economy tariff.

If your contractor has set this function, DHW is only heated in the **"ECO"** and **"AUTO"** operating programs if the economy tariff is active. If the economy tariff is active, the  symbol flashes.

With the **"BOOST"** and **"SMART"** operating programs, you can switch on DHW heating at any time, regardless of the electricity tariff.

Note

The **"PROGRAM"**  operating program and the time setting  are no longer available.

Enable premium/economy tariff

The premium/economy tariff must have been connected and enabled by your contractor.

Select the **"ECO"** or **"AUTO"** operating program.

Premium/economy tariff is used.

When electricity is cheaper (economy tariff), the  symbol flashes.

Note

The **"BOOST"** and **"SMART"** operating programs continue to be available at any time.

Minimum stop time function

The heat pump switches off once the standard DHW temperature has been reached.

To prevent constant stopping and starting, the heat pump remains off for the duration of the minimum stop time (approx. 5 minutes). This increases the service life of your heat pump.

The flashing  symbol indicates that the heat pump will start again once the delay has expired.

Childproofing

No input is possible at the programming unit when childproofing is enabled.

To switch childproofing on or off, press the **+** and **-** buttons simultaneously.

Displays:

"LOCK" Childproofing ON

"L--CK" Childproofing OFF

Restoring factory settings (reset)

Note

Not possible if a fault message is active, with the "Increased DHW hygiene" function or in the "PRO-GRAM"  operating program.

1. Press  and **OK** simultaneously for 3 seconds. "RST?" is displayed.

2. Confirm with **OK**. "dONE" appears.
The factory settings have been restored.

Note

Time and date need to be set again.

3. Use  to exit "RST?".

Checks

Checking information

The following information can be checked:

- Annual consumption: Power consumption as calculated by the control unit. The actual power consumption may vary.
- Proportion of DHW heating provided by the immersion heater and the heat pump in the last 30 days

Example:

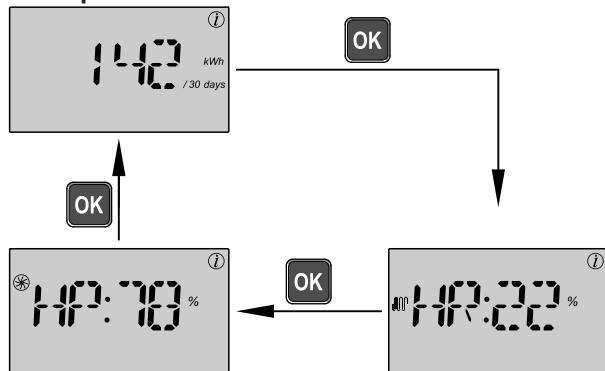

Fig. 22

Display	Meaning
"142" "kWh / 30 days"	The appliance consumed 142 kWh in the last 30 days.
☹ "HR:22" %	Time percentage of DHW heating provided by the immersion heater in the last 30 days: 22 %
⊗ "HP:78" %	Time percentage of DHW heating provided by the heat pump in the last 30 days: 78 %

Checking messages

Messages are shown if your DHW heat pump experiences particular events or operating conditions.

Displaying information

1. Use **≡** to select information ⓘ.
2. Use **OK** to switch between displays.

Note

To reset the values, press **≡** and **OK** simultaneously.

3. Use **≡** to return to the last operating program.

Switching off the DHW heat pump

With frost protection monitoring

Set the **"OUT"** operating program (holiday program) for the required time; see page 13.

If the DHW temperature falls below 5 °C, the frost protection function is enabled.

No frost protection monitoring

Disconnect the power plug.



Please note

If outside temperatures of below -5 °C are expected, take appropriate measures to protect the DHW heat pump from frost.
If necessary, contact your contractor.

Notes on taking the appliance out of use

When restarting, you may have to reset the time and date (see page 18).

Switching on the DHW heat pump

After being taken out of use or a power failure lasting longer than 24 hours

1. Check that the power plug is plugged in. Switch on the power supply, e.g. at a separate fuse or a mains isolator.
After a few seconds, the appliance starts in the **"ECO"** operating program. "--:--" flashes.

2. Note

If the time and date are displayed alternately, see page 18.

Press any button.

The appliance is ready for operation. The set DHW temperature for DHW heating is 53 °C.

"OUT" operating program (standby mode, holiday program)

Use  to select the required operating program.

What to do if...

DHW heat pump does not start

Cause	Remedy
<ul style="list-style-type: none"> ▪ The power plug is not plugged in. ▪ An ON/OFF switch installed on site has not been switched on. 	<ul style="list-style-type: none"> ▪ Insert the power plug into the socket. ▪ Turn on the mains isolator.
There is no power at the socket.	Check the fuse in the power distribution board (main domestic fuse).
The "OUT" operating program (holiday program) is selected.	Use  to select the required operating program.
Your DHW heat pump has only just shut down and cannot restart immediately.	No action required. The minimum stop time is active. Wait approx. 5 minutes.
A message (" ER 0 " to " ER 10 ") is displayed.	Notify your contractor. Tell your contractor which fault message is being displayed.

No input is possible at the programming unit

Cause	Remedy
Childproofing is on.	Press + and – simultaneously. Displays: "LOCK" Childproofing ON "L--CK" Childproofing OFF

Cleaning

The appliance surfaces can be cleaned with a commercially available domestic cleaning agent (non-scouring).

No splashes of water must enter the DHW heat pump.

Inspection and maintenance

The inspection and maintenance of a heating system is prescribed by the German Energy Saving Ordinance [EnEV] and the DIN 4755, DVGW-TRGI 2018, DIN 1988-8 and EN 806 standards.

Regular maintenance ensures trouble-free, energy efficient, environmentally responsible and safe heating. Your heating system must be serviced by an authorised contractor at least every 2 years. For this, it is best to arrange an inspection and maintenance contract with your local heating contractor.

DHW cylinder

Standards DIN 1988-8 and EN 806 specify that maintenance or cleaning should be carried out no later than 2 years after commissioning and as required thereafter.

Only a qualified contractor may clean the inside of the DHW cylinder, including the water connections. If any water treatment equipment (e.g. a sluice or injection system) is installed in the cold water supply of the DHW cylinder, ensure this is refilled in good time. For this, observe the manufacturer's instructions.

We recommend an annual function check of the protective magnesium anode by your contractor. The function of the protective magnesium anode can be checked without interrupting operation. The contractor will check the earth current with an anode tester.

Safety valve (DHW cylinder)

The function of the safety valve must be checked every six months by the user or a contractor through venting (see valve manufacturer's instructions). The valve seat may become soiled.

Water may drip from the safety valve during a heat-up process. The outlet is open to the atmosphere.



Please note

Overpressure can cause damage. Do not close the safety valve.

Potable water filter (if installed)

To maintain high hygiene standards, proceed as follows:

- Replace filter element on non-back flushing filters every six months (visual inspection every two months).
- On back flushing filters, back flush every two months.

Damaged cables/lines

If there is damage to the connecting cables or lines of the appliance or externally installed accessories, these must be replaced with special cables or lines. Use only Toshiba cables/lines as replacement. For this, contact your qualified contractor.

Information on disposal

Disposal of packaging

Your contractor will dispose of the packaging from your Toshiba product.

Final decommissioning and disposal of the heating system

Toshiba products can be recycled. Components and fluids from your heating system do not belong in ordinary domestic waste. Please speak to your contractor about the correct disposal of your old system.

Keyword index

A		L	
Air intake temperatures.....	7	Lower cylinder temperature sensor.....	16
B		M	
Buttons.....	9	Maintenance.....	23
C		– Cleaning.....	23
Check		– DHW cylinder.....	23
– Information.....	FJ	Minimum stop time function.....	18
– Message.....	FJ	P	
Childproofing.....	Fİ	Permissible air intake temperatures.....	7
Cleaning.....	GG	Photovoltaic system, energy saving.....	8
Comfort (tips).....	8	Power failure.....	7
Commissioning.....	7	Power from photovoltaic system.....	17
Controls.....	9	Power plug.....	21
Control unit operation.....	9	Power supply.....	21
D		Premium/economy tariff.....	18
Day.....	1İ	R	
Default setting.....	7	Reset.....	19
Delivered condition.....	7	S	
DHW		Service contract.....	23
– Temperature setting.....	10	Setting	
– Time program.....	15	– DHW temperature.....	10
DHW cylinder.....	2G	Shutdown.....	21
DHW demand.....	16	Standby mode.....	13
DHW heating		Switching off	
– Comfort.....	8	– Heat pump.....	21
– Energy saving.....	8	– No frost protection monitoring.....	21
DHW hygiene.....	16	– With frost protection monitoring.....	21
Display.....	9	Switching on	
Display elements.....	9	– Heat pump.....	21
E		T	
Energy saving (tips).....	8	Temperature.....	10
F		Time.....	17
Factory setting.....	7	Time program, setting.....	15
Factory settings.....	1İ	Tips	
Fault		– Comfort.....	8
– Checking.....	FJ	– Energy saving.....	8
– DHW heat pump.....	2F	U	
Frost protection.....	13	Upper cylinder temperature sensor.....	16
H		Utilisation of power generated on site.....	8, 16
Heat pump			
– Switching off.....	2€		
– Switching on.....	2€		
I			
Information, checking.....	FJ		
Inspection.....	23		